

Features

- RAH Series offers one unique holder design that fits with multiple types of ZOOK Reverse-Acting metal rupture disks (RA4, RA6, RA8, RAX)
- Pre-Torque Design allows for:
 - a) Pre-assembly of a rupture disk into a holder prior to field installation
 - b) Removal of the assembly from the piping system for inspection without disturbing the seal integrity of the rupture disk
 - c) Pre-torque bolts properly seat the disk by engaging the holder bite
- Disk Dome is contained within holder's inlet, which prevents damaging the disk during installation into mating flanges
- Locating Pin allows only reverse-acting type disks to be mounted into holder
- Fluoropolymer coated socket head cap screws resists corroding to holder assembly and provides easy removal without special sockets
- Polyethylene cap screw covers prevents debris from building up in cap screw head
- Sizes 1" thru 12"
- Standard cast holder materials: Carbon Steel (WCB), Stainless Steel (CF3M), Hastelloy (CW12MW)
- Holder information is permanently affixed to the O.D. of holder
- Bubble tight metal-to-metal bite and disk seal
- Flow direction arrows on disk tag and holder provides permanent visual verification that holder assembly is properly oriented in the piping system
- ANSI, DIN, and JIS Flange class and type specific, guards against installing an assembly into mating flanges with a different pressure rating than the rupture disk holder
- Positioning hole in mounting lug is located in the exact position as the mating flange and allows for proper alignment. It can also be used as an extra "hand" when installing into horizontal piping
- For custom materials and alternative flanges (types/ratings) ZOOK offers custom inserts (RAHI) or full flanges (RAH7) and custom overall heights

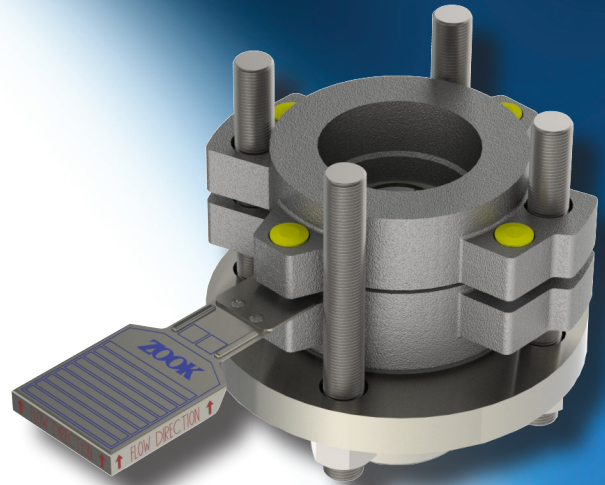

RAH (Pre-torque holder)

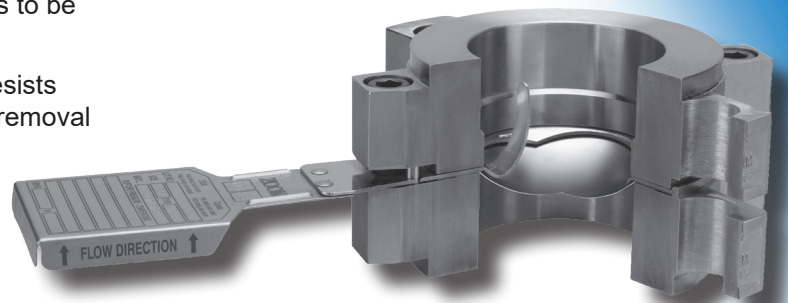

Cut-out view of RAH (Pre-torque holder)

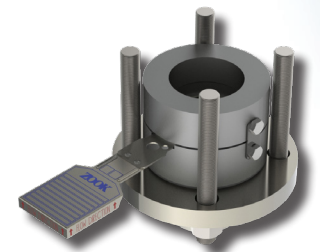

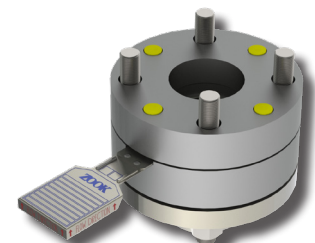

RAHI (Insert holder)



RAH7 (Full flanged pre-torque holder)

RAH Series Specifications

Holder Dimensions / Specifications

Nominal Size	Available Flange Class* (ANSI / DIN)	Minimum Height [♦] (in. / mm)	Standard Height (in. / mm)			Weight (Short Pattern) (lbs / kgs)	Number of Cap Screws	Cap Screws Hex Size (in.)	Gauge tap (NPT) (in.)
			Short Pattern RAH 	Mid Pattern RAH-LP1 	Long Pattern RAH-LP2 				
1"	150/300/600	1-9/16	2-1/8	2-11/32	2-9/16	3.8 lbs	4	3/16	1/8, 1/4
25 mm	10/16/25/40	39.68	53.97	59.53	65.09	1.72 kgs	4	3/16	1/8, 1/4
1-1/2"	150/300/600	1-11/16	2-1/4	2-29/32	3-9/16	6.4 lbs	4	1/4	1/8, 1/4
40 mm	10/16/25/40	42.86	57.15	73.82	90.49	2.9 kgs	4	1/4	1/8, 1/4
2"	150/300/600	2-5/32	2-23/32	3-15/16	5-5/32	9.0 lbs	4	5/16	1/8, 1/4, 1/2
50 mm	10/16/25/40	54.77	69.06	100	130.97	4.08 kgs	4	5/16	1/8, 1/4, 1/2
2-1/2"	150/300/600	2-9/16	3-1/8	4-15/16	6-23/32	16.6 lbs	4	3/8	1/8, 1/4, 1/2
65 mm	10/16/25/40	65.09	79.38	125.41	170.66	7.5 kgs	4	3/8	1/8, 1/4, 1/2
3"	150/300/600	2-9/16	3-1/8	4-15/16	6-23/32	16.6 lbs	4	3/8	1/8, 1/4, 1/2
80 mm	10/16/25/40	65.09	79.38	125.41	170.66	7.5 kgs	4	3/8	1/8, 1/4, 1/2
4"	150/300	2-19/32	3-5/32	5-31/32	8-3/4	22.5 lbs	4	3/8	1/8, 1/4, 1/2
100 mm	10/16/25/40	65.88	80.17	151.61	222.25	10.2 kgs	4	3/8	1/8, 1/4, 1/2
6"	150/300	3-7/32	3-7/16	6-25/32	10-3/32	36.00 lbs	8	5/16	1/8, 1/4, 1/2
150 mm	10/16/25/40	81.76	87.31	172.24	256.38	16.33 kgs	8	5/16	1/8, 1/4, 1/2
8"	150/300	4-1/16	4-5/8	9-1/32	13-15/32	53.4 lbs	8	3/8	1/8, 1/4, 1/2
200 mm	10/16	103.19	117.48	229.39	342.11	24.22 kgs	8	3/8	1/8, 1/4, 1/2
10"	150	4-3/4	5-21/32	11-5/32	16-11/16	99.8 lbs	12	3/8	1/8, 1/4, 1/2
250 mm	10/16	120.65	143.67	283.37	423.86	45.27 kgs	12	3/8	1/8, 1/4, 1/2
12"	150/300	5-1/16	6-17/32	13-5/32	19-25/32	136.00 lbs	12	1/4	1/8, 1/4, 1/2
300 mm	10/16	128.59	165.89	334.17	502.44	61.69 kgs	12	1/4	1/8, 1/4, 1/2

Notes:

- * Holders are also available to fit JIS flanging. Contact ZOOK for details.
- ♦ Minimum height specified in table above will maintain the pre-torque feature of the rupture disk holder.
- Refer to ASME/ANSI B16.5 pipe flanges and flange fittings (Table 2) for max allowable pressure/temperature ratings per flange class.

Options / Accessories

Short / Mid / Long Pattern

- Can be machined to meet existing piping specifications
- Mid / Long Pattern prevents rupture disk membrane from protruding beyond the outlet holder after burst

Replacement Fluoropolymer Coated Cap Screws



Cap Screw Specifications**	
Type	Socket Head
Material	Alloy Steel
Hardness	38-43-RC
Threads	UNRF 3A

** Required to meet Pre-Torque specifications

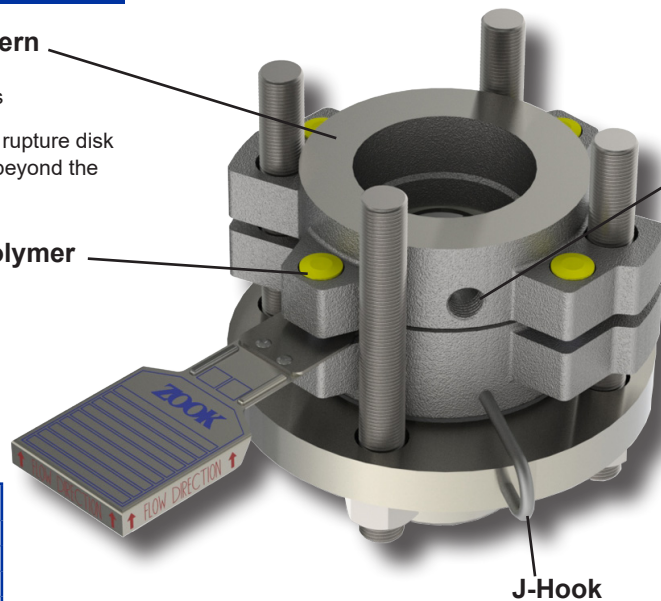

Eye Bolt

- To assist in lifting



Gauge Tap

- Used for monitoring pressure/temperature at rupture disk location
- Also available on inlet holder

PTFE Sleeved Holder Inlet

- Ideal for corrosive applications and reducing product build-up (Refer to PTFE Sleeved Holder Inlet Data Sheet)

Tantalum Coating

- Ideal for extreme corrosive applications and higher temperatures

Teflon - TM The Chemours Company
Hastelloy - TM Haynes International



RAH_052020

Visit us at www.zookdisk.com

SERVING AMERICA, CENTRAL & SOUTH AMERICA

16809 Park Circle Drive
Chagrin Falls, Ohio 44022
United States

Toll Free: +1 800 543 1043
Phone: +1 440 543 1010
Fax: +1 440 543 4930
E-mail: sales@zookdisk.com

SERVING EUROPE, MIDDLE EAST & AFRICA

Navigation House, Bridge St.
Killamarsh, Sheffield, S21 1AL
United Kingdom

Phone: +44 (0) 1909 560999
Fax: +44 (0) 1909 560860
E-mail: sales.europe@zookdisk.com

SERVING CANADA

4400 South Service Road
Burlington, Ontario, L7L 5R8
Canada

Toll Free: +1 800 370 6057
Phone: +1 905 681 2885
Fax: +1 905 681 8838
E-mail: sales.canada@zookdisk.com

SERVING ASIA PACIFIC

Unit No. 23A-05, Menara Landmark
No.12, Jalan Ngee Heng
80000 Johor Bahru, Johor,
Malaysia

Phone: +60 (7) 2910099
Fax: +60 (7) 2910096
E-mail: sales.asia@zookdisk.com



Safety through knowledge and performance.