



TRICENTRIC[®] BD SERIES

TRIPLE OFFSET BUTTERFLY VALVES



SCORE VALVES' COMPANY ADVANTAGE

Score Valves is an engineered valve solutions company headquartered in North America. Founded in 1988, we have had a continuous customer focus on butterfly valve design, manufacture and distribution.

Our rich history of engineering customization gives us the knowledge base necessary to design valve products for the most demanding applications. We serve customers across a broad range of industries including refining, petrochemical, power, nuclear, pulp and paper, LNG-cryogenics, aerospace, utilities and mining.

ENGINEERED VALVE SOLUTIONS

Our experienced sales engineers work closely with engineers, original equipment manufacturers and project managers to quote the specific product configurations required.

For each solution, Score Valves provides engineering services consulting for application, material selection, design, sizing, cavitation, noise control, cryogenic and emissions testing.

CUSTOMER FOCUSED SUPPORT

Score Valves' customer focus ensures minimized downtime by supplying original equipment replacement parts at accelerated lead times along with after-market service through:

- › Large stock of standard and special spare parts and cast components
- › Quick turnaround on all non-standard components
- › Fully warranted OEM parts of uncompromising quality
- › Dedicated customer focused personnel
- › OEM authorized service crews

TRICENTRIC®

Introduced in the 1970s as the first triple offset butterfly valves in North America, TRICENTRIC® has made its way to becoming a brand leader.

BEST OVERALL PERFORMANCE

Manufactured by Score Valves, TRICENTRIC® is recognized in the market for excellent flow and control characteristics, sealing capabilities (zero leakage bidirectional) and dependability in a wide range of applications. The high quality metal seated valve not only meets or exceeds engineering standards, but is also supported by an established network of distributors and sales representatives across the globe.

LOW COST OF OWNERSHIP

TRICENTRIC® triple offset butterfly valves meet industry requirements and provide low cost of ownership to the end user through improved life cycle costs, emissions control, less downtime and low maintenance costs. When compared with ball, gate and globe valves, TRICENTRIC® offers some of the lowest costs for factors such as installation, maintenance, piping support, etc.

AUDITED QUALITY AND PERMITTED ENGINEERING

- › Quality program fully compliant with ISO-9001 since 1990
- › Boiler Safety Association registered design (CRN OC00765.2) TRICENTRIC®
- › Boiler Safety Association certificate of authorization permit approved facility
- › Quality program for construction, repair or alteration of Category C fittings
- › Association of Professional Engineers approved permit to practice facility
- › Audited by the FDA, major oil and gas, aerospace and air separation organizations for quality management, facility and cleaning processes

PERFORMANCE	TRICENTRIC®	BALL	GATE	GLOBE
Shutoff	Zero	Low	High	High
Emissions	Low	Low	High	High
Pressure Drop	Moderate	Low	Mod	High
Cv Flow Coefficient	Moderate	High	Mod	Low
Inherently Fire Safe	Yes	No	Yes	Yes
Bidirectionality	Yes	Yes	Yes	Yes
Large Size Suitable	Yes	Yes	Yes	No
Control Suitable	Yes	No	No	Yes
Quick Operation	Yes	Yes	No	Yes
Inherent Flow Characteristics	Equal %	Quick	Quick	Equal %
Rangeability	10:1	3:1	N/A	30:1



FEATURES AND BENEFITS

SEAT AND SEAL

- › **TRIPLE OFFSET METAL SEATED DESIGN**
- › **LONG LIFE SEATS**
Seat design eliminates galling and minimizes seat/seal wear.
- › **RAISED, CONICAL SEAT**
Prevents solids buildup from interfering with the seal.
- › **TORQUE SEATED**
Not position seated, as with soft seated designs, which means no need to find the “sweet spot” for sealing.
- › **METAL SEAL**
Not subject to “set,” as can occur in soft seated designs, resulting in long term sealing performance.
- › **LAMINATED RESILIENT DISC SEAL**
Standard stainless steel and graphite laminated resilient disc seal to 1200°F (650°C). Alternate materials, solid and o-ring construction available for specialty and abrasive services.
- › **BIDIRECTIONAL SHUTOFF**
Zero leakage bidirectional shutoff to API 598 resilient standard.
- › **SELF-COMPENSATING SEAL**
Self-compensating resilient seal allows disc movement during alternating flow direction, fast closure or thermal cycling to maintain tight shutoff.
- › **PRESSURE-ASSISTED SHUTOFF**
Seating improves as pressure increases when installed in standard preferred direction.
- › **RAISED FACE SEALING OPTIMIZED**
Uninterrupted by seat/seal retainer bolt holes as with soft seated designs.

SHAFT AND BEARINGS

- › **BLOW OUT PROOF SHAFT**
One piece blow out proof shaft conforms to API 609. Large diameter shaft incorporates three blow out prevention features: internally at thrust bearing and disc connection and externally at the gland flange.
- › **KEYED AND PINNED SHAFT**
Connection to disc results in improved operational reliability.
- › **LONGER AND LARGER BEARING**
Extended length shaft bearings with larger shaft diameter have an increased bearing area with longer service life. Bearings are standard of wear and galling resistant graphite, chrome plated stainless steel or CoCr hardsurfacing (optional).
- › **BEARING PROTECTORS**
Installed standard with braided graphite to prevent the entry of particulate into bearing areas. Energized bearing seals (optional) are available for complete bearing isolation from aggressive media.
- › **LOW EMISSION SHAFT SEAL**
Standard graphite packing conforming to API 622. Live-loading in alloy, stainless steel or Inconel® is available for extended low emission compliance.

DESIGN

- › **FIRE SAFE DESIGN**
Inherent fire safe design: all metal construction and graphite soft goods provide inherent fire safe function. Tested to API 607.
- › **STANDARDIZED DIMENSIONS**
Standardized valve mounting pad dimensions conform to ISO 5211 and MSS-SP101.
- › **HIGH QUALITY STANDARD CASTINGS**
Dye penetrant, magnetic particle and radiographic sampling inspection to ASME B16.34, performed on castings as part of standard inspection processes—compliant to ISO 9001.
- › **DESIGNED FOR BIDIRECTIONAL SHUTOFF**
Disc designed for dead end service—bidirectional shutoff to full ASME class body rating.
- › **EXCELLENT THROTTLING CHARACTERISTICS**
- › **STANDARD FACE TO FACE DIMENSIONS**
Conform to API 609, ASME B16.10, ISO 5752 and MSS-SP-68.



PERFORMANCE

PRESSURE AND TEMPERATURE

TRICENTRIC® metal seated valves perform favorably when compared to conventional, resilient seated and high performance butterfly valves over all service ranges. They perform exceptionally well at high pressure and temperature applications due to the following features:

- › Robust design and construction
- › Flexible seal stack
- › Interference-free metal seats
- › Bidirectional sealing
- › Zero leakage
- › Inherently fire safe

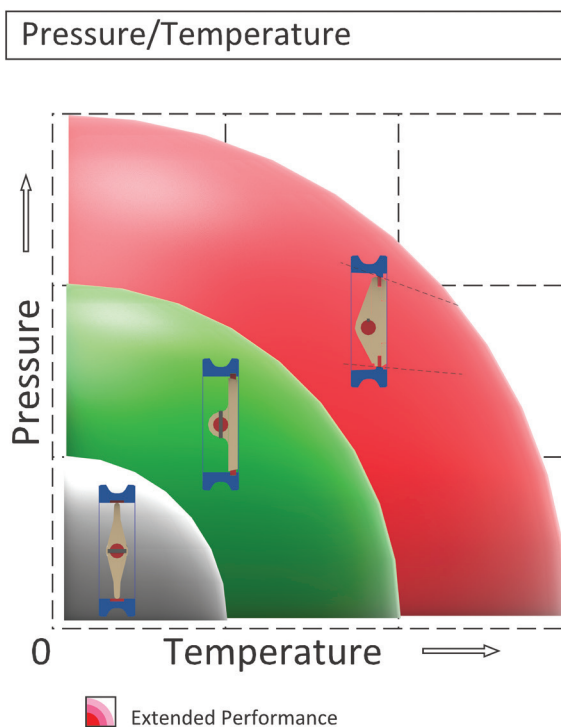

OFFSET PERFORMANCE COMPARISONS

TRICENTRIC® (TRIPLE OFFSET)

Incorporate 3-way eccentricity. The metal seat is capable of very tight shut off at temperatures beyond 1200°F.

HIGH PERFORMANCE (DOUBLE OFFSET)

The eccentric shaft results in an uninterrupted seal which can be used at higher pressures and temperatures. However, the resilient seats wear and can plug with solids.

CONVENTIONAL (SINGLE OFFSET)

Center shaft which penetrates a resilient seal. Suitable for low temperature, low pressure services only.

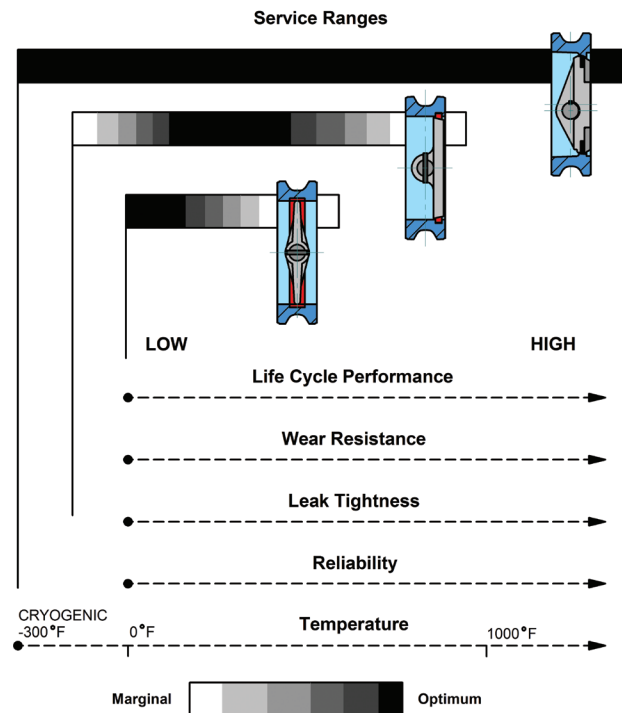

PRINCIPLE OF OPERATION

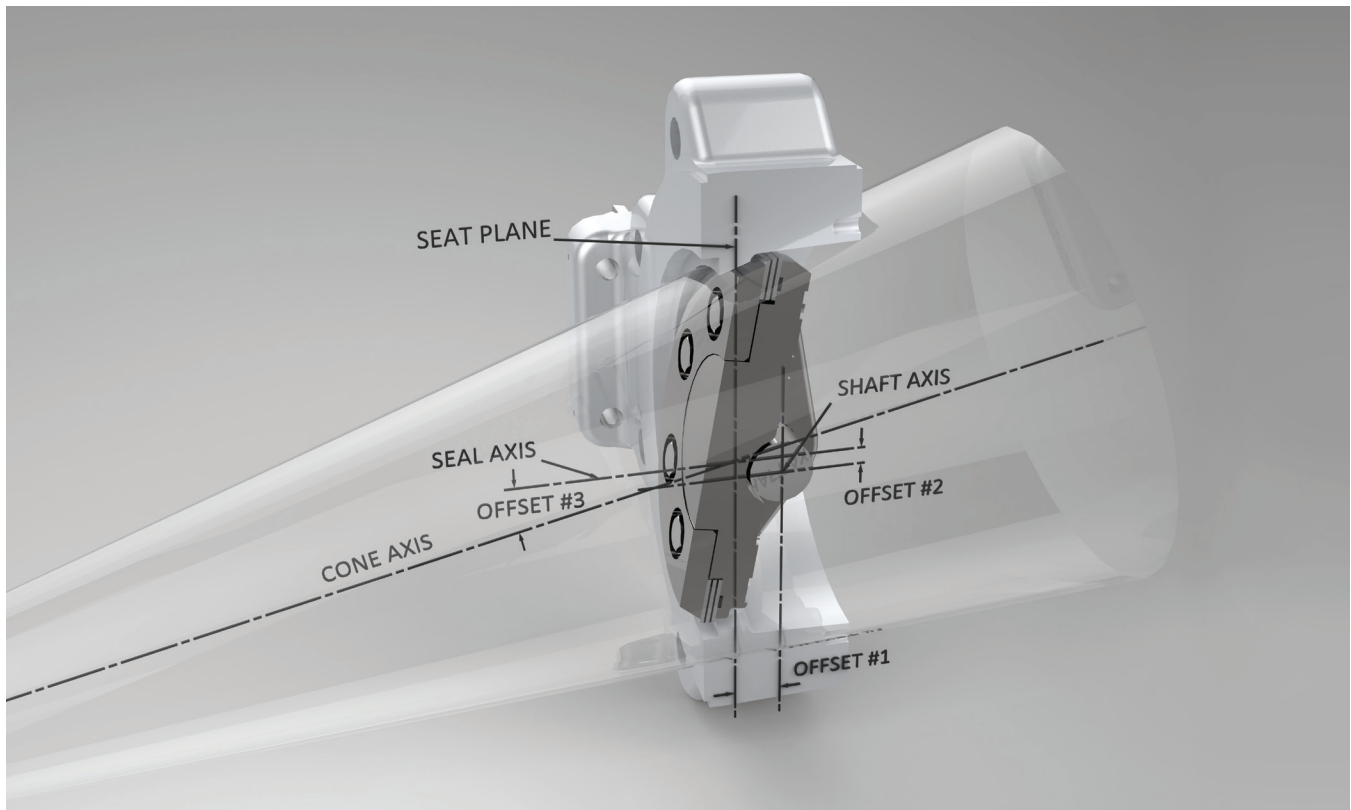

TRIPLE OFFSET SEALING SYSTEM

OFFSET #1

The shaft is offset from the seat plane providing an uninterrupted seating surface.

OFFSET #2

Centerline of disc/seal is offset from the centerline of the shaft allowing the seal to freely lift off and away from the seat on opening.

OFFSET #3

The cone axis is offset from the centerline of the seal to provide a conical sealing surface that allows the seal to rotate in and out of the seat without interference.

The principle of operation incorporated in the TRICENTRIC® triple offset valve is geometry in motion. Both the seat in the body and the seal on the disc are surfaces of a cone which are sectioned at an angle. The valve shaft is located slightly to one side of the seat center and above the plane of the seat. Its center of rotation is also somewhat offset from the axis of the imaginary cone which extends from the surface of the seat.

When the valve is closed, the surface of the seal and the seat are in full contact at all points. Any effort to try to further close the disc (rotating it into the seat) increases the sealing force and tightens the valve. This allows the valve to achieve a bidirectional seal.

Opening the valve (rotating the disc away from its seat) results in the seal moving away from the seat at all points, eliminating galling and minimizing seat/seal wear. TRICENTRIC® valves feature true non-rubbing seating surfaces for long life and tight shutoff.

THE TRICENTRIC® SEAL

The TRICENTRIC® valve seal stack is designed to provide optimal sealing over the total product range. This is achieved by employing a laminated seal stack (stainless steel and graphite standard materials). The number of laminations is dependent on the size and pressure class and is critical to performance. For high temperature or aggressive applications, a laminated or solid all metal seal is available. A solid seal with metal or elastomeric o-ring for oxygen or cryogenic service is also available. BAM oxygen approved materials as well as a full range of optional metal, lamination and o-ring materials are available to suit specific application environments.

The TRICENTRIC® valve seal stack is resilient and self-compensating to maintain tight shutoff by allowing disc movement during alternating flow direction, fast closure or thermal cycling to maintain tight shutoff.

FEATURES	BENEFITS
Metal to Metal Seating Surface	<ul style="list-style-type: none"> › Inherently fire safe › -423°F to 1500°F temperature range › Minimized seat/seal wear (not subject to abrasion and tearing, as with soft-seated designs) › Long term performance (not subject to "set," as with soft seated designs)
Torque Seated	Zero leakage
Third Offset and Conical Seat	Repeatable seat tightness, seal self-compensating during thermal cycling
Quarter Turn	Quick opening and closing

SEAL CONFIGURATION OPTIONS



METAL AND GRAPHITE LAMINATED

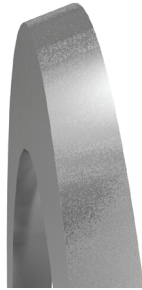

METAL SOLID

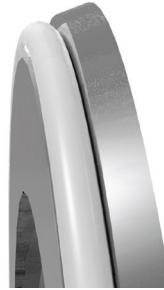

METAL SOLID WITH ELASTOMER OR METAL O-RING

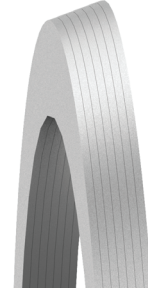

METAL-ONLY LAMINATED

VALVE TESTING

LIFE CYCLE

TRICENTRIC® valves have been tested extensively under a wide range of conditions in order to validate performance of the critical components (gasket, seal stack and bearing/shaft material). The overall design and tolerances have been tested rigorously to meet industry life cycle standards.

CRYOGENIC

TRICENTRIC® valves have proven seal reliability for liquid oxygen, liquid nitrogen, liquid hydrogen and liquid natural gas services as required by NASA, the aerospace industry, oil field recovery services and other extreme applications.

In an independent laboratory test, after more than three hours submerged in liquid nitrogen at -321°F and 145 psig, the TRICENTRIC® valve met all the specification requirements, including zero leakage with helium.

TRICENTRIC® valves achieve tight shut-off, zero leakage at temperatures to -423°F in liquid oxygen, nitrogen, hydrogen and natural gas applications.

DURABILITY

Testing has been performed to establish the durability of the seal stack and validate the overall design.

BRACKISH WATER

TRICENTRIC® valves were cycled using brackish water to validate the bearing/shaft combination and determine the effect of brackish water on standard components.

FIRE

TRICENTRIC® valves meet or exceed API 607.

SULFUR

TRICENTRIC® valves are designed to cut through solidified sulfur in seating and bearing areas with no seal damage or interruption of service.

FUGITIVE EMISSIONS

TRICENTRIC® valves comply with ISO 15848 and Method 21 tests. This includes cycle testing valves up to 5000 times over three thermal cycles, from ambient to 350°F with no packing adjustments required over the duration of the test.

MARKETS SERVED



TRICENTRIC® valves are installed worldwide across a range of industries.

Score Valves has an extensive list of customer references, organized by market segments. These lists are available from our Sales Department upon request.

OIL AND GAS/REFINING

TRICENTRIC® valves are found in all sectors of the oil and gas market (upstream, midstream and downstream). They are designed to all applicable standards in order to meet the demands of the refining industry: API 609 and API 607.

- › Ballast valve
- › Co-generation
- › Coker light ends
- › Cryogenic LNG isolation
- › Dirty hot cracking gas stop and control
- › Dump valve (offshore)
- › Flare gas hydrogen and sour gas control and isolation
- › Fluidized catalytic cracker
- › Fuel oil storage isolation
- › Gasification air separation
- › Gasoline
- › Hydrogen processes
- › Hydrotreating processes
- › Light ends
- › Molten sulfur
- › Refinery desulfurization cooling water
- › Reforming processes
- › Steam supply stop and control
- › Stop and control valves
- › Sulfur condenser switch
- › Tank farm

AEROSPACE

- › Launch pad sound suppression
- › Liquid or gaseous oxygen fuel transport and storage
- › Liquid or gaseous hydrogen fuel transport and storage

CHEMICAL PROCESSING

Staying competitive in the global petrochemical market is all about the cost of production. The long life of TRICENTRIC® valves helps to reduce cost of ownership for the plant.

- › Acid gas
- › Brine
- › Caprolactam
- › Chlorine gas
- › CO₂ vapor
- › Cooling water
- › Emergency closure valves to isolate in one second or less
- › Ethylene
- › Flare inlet control and manifold isolation
- › Furnace isolation
- › Hot gases
- › Hydrogen gas
- › Liquid or gaseous oxygen
- › Phenol
- › Phosgene
- › Propylene
- › Process gas
- › Steam
- › Tail gas
- › Vinyl chloride monomer (VCM)

AIR SEPARATION AND CRYOGENIC

- › Liquid or gaseous oxygen
- › Liquid or gaseous nitrogen
- › Liquid or gaseous hydrogen

MARKETS SERVED



PULP AND PAPER

Global competition in pulp and paper mills means operators are looking for cost effective valves to stay up and running. TRICENTRIC® valves can be found in all steps of the pulping process: the recovery area, stock prep, paper making and within the bleach plant.

- › Alcohol reduction process
- › Lime mud slurries
- › Boiler water
- › Mill water
- › Demineralized water
- › Oxygen systems
- › Digester gas off
- › Steam isolation
- › Green, red, black and white liquors
- › Stock solutions
- › Isolation and check valves for steam
- › Water treatment

CONVENTIONAL POWER

Regulatory compliance and fuel costs make operating efficiency a priority in this sector. Through superior products, service and support, Score Valves is improving the availability and output of existing plants, from coal to combined cycle processes, helping our customers meet tough commercial and environmental targets.

- › Condenser cooling
- › Heat exchanger isolation
- › District heating and cooling
- › Low pressure gate valve replacement
- › Emergency heater drain
- › Pump isolation
- › Extraction steam isolation
- › Stop and control valves
- › Fuel gas isolation
- › Suppression system

MUNICIPAL SERVICE

- › District heating
- › Potable water
- › Water/wastewater

SPECIAL APPLICATIONS

- › CO₂ recovery
- › Liquid oxygen
- › Cryogenic
- › Mining
- › Food and beverage
- › Molten sulfur
- › Geothermal plants
- › Molten salt
- › High temperature gases and heated slurries such as SO₂ and lime kiln feed
- › Steam turbine generation stop and control valves
- › Hospitals
- › Universities



SCORE VALVES' PRODUCTS

DESIGN STANDARDS

- › ASME B16.34
- › API 609
- › ASME B16.25 butt weld end
- › API 600 double flange long pattern wall thickness

PRESSURE CLASSES

- › ASME CL. 150, 300 and 600 (stocked standard)
- › ASME CL. 900 and 1500 (available upon request)

SIZES

- › NPS 3-36 (stocked standard)
- › NPS 38-96 (available upon request)

MATERIALS OF CONSTRUCTION

- › Carbon steel (A216 WCB stocked standard)
- › Stainless steel (A351 CF8M stocked standard)
- › Monel® (trim stocked standard)
- › All other materials available upon request including: alloy steel, duplex steel, super austenitic, Inconel®, Hastelloy®, nickel-aluminum-bronze, and titanium

TESTING

- › ASME B16.34
- › API 598 zero leakage resilient high and low
- › API 607
- › ASME/FCI 70-2 Class V and VI

PRODUCTS

BODY TYPE/END CONNECTION



WAFFER TYPE

Face to face to API 609

Flange standard ASME B16.5, B16.47 Ser. A and B, ASME Sec VIII, Div.1 App.2 (>60 NPS)

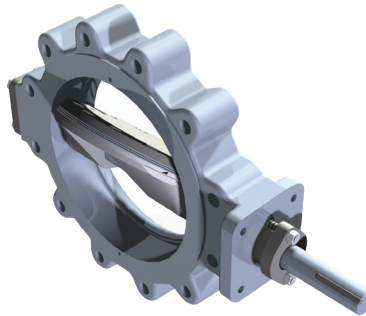

LUG TYPE

Face to face to API 609

Flange standard B16.5, B16.47 Ser. A and B, ASME Sec VIII, Div. 1 App.2 (>60 NPS)



DOUBLE FLANGED SHORT PATTERN

Face to face to API 609 and ISO 5752

Flange standard B16.5, B16.47 Ser. A and B, ASME Sec VIII, Div. 1 App.2 (>60 NPS)

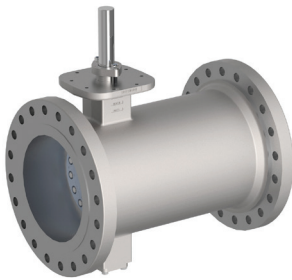

DOUBLE FLANGED LONG PATTERN

Face to face to ASME B16.10, API 609

Flange standard B16.5, B16.47 Ser. A and B, ASME Sec VIII, Div. 1 App.2 (>60 NPS)

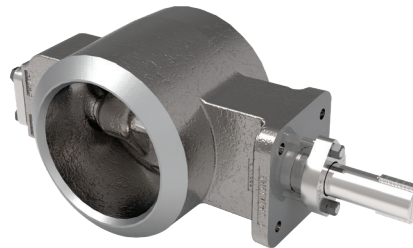

BUTT WELD END

End to end based on customer requirements

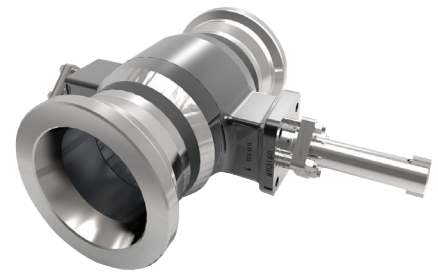

SPECIALTY TYPE/END CONNECTION

Per customer requirements:
AWWA C207, B16.1, DIN, flat, RTJ,
o-ring, T&G, clamp joint, custom

PRODUCTS

OPTIONS

ACTUATORS AND ACCESSORIES

- › Manual gear operator (stocked standard)
- › Pneumatic
- › Electric
- › Hydraulic
- › Actuator accessories: hand wheel override, limit switches, solenoid valves, positioner, speed controls, partial stroke device, heat shielding and fireproofing
- › Gear and actuator rigid and flexible extensions

ADDITIONAL OPTIONS

- › Hardsurfacing-welded, HVOF and flame spray
- › Coating and plating-chrome, nickel, copper, silver plating; TFE, PTFE and Ti-Nitride plasma vapor deposition
- › Elastomeric seat
- › Bolt-on steam jacket
- › Live-loaded packing
- › Low emission packing to 100 ppm per API 622
- › Purged or lubricated packing or bearings
- › NASA/aerospace compliant
- › NACE MR 0103 or NACE MR 0175 compliant
- › Counter clockwise to close
- › 3-way linked valves
- › Spool piece, spacer plate
- › Splined high vibration connection
- › Controlled orifice disc
- › Orifice plate
- › Vacuum service
- › BAM certified
- › Degreased and packaged for GOX, LOX, GH2, LH2, CL2 and FDA compliance
- › Pickled and passivated ASTM compliant
- › Cryogenic tested to BS6364, NASA specification
- › Fugitive emission testing per ISO 15848
- › Controlled country material source
- › NDE, weld, metallurgy and heat treatment special control
- › Outboard bearings
- › Reduced port trim
- › Reduced pressure class trim
- › Block and bleed

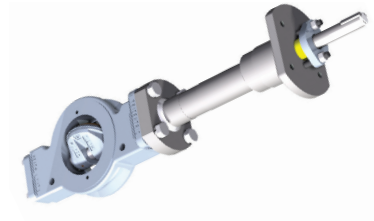

CRYOGENIC EXTENSION



HEAT EXTENSION

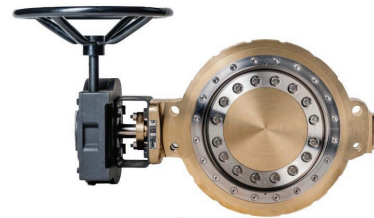

REPLACEABLE SEAT

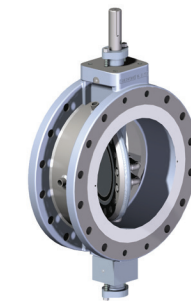

**STEAM JACKET BODY/
TRACED DISC AND SHAFT**



REDUCED PORT TRIM

STANDARD MATERIALS OF CONSTRUCTION

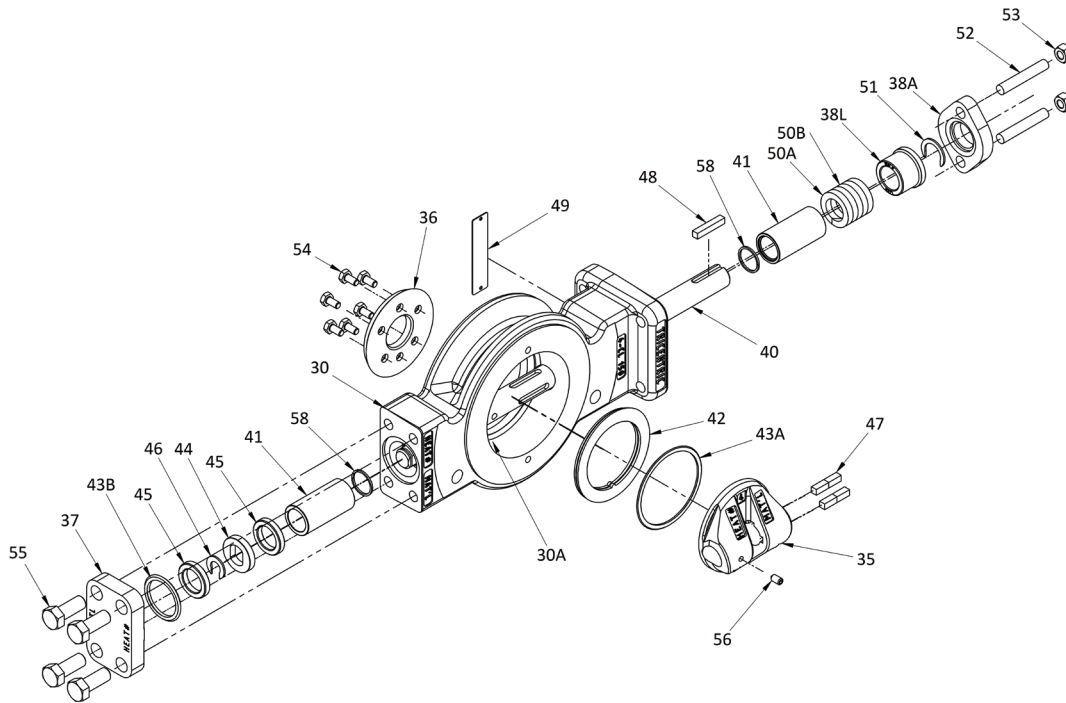

ITEM NO.	COMPONENT	MATERIAL: CARBON STEEL VALVE	MATERIAL: 316 STAINLESS STEEL VALVE
30	Body	A216 Gr. WCB	A351 Gr. CF8M
30A	Seat	316 SST Overlay integral with body	Integral with body
35	Disc	A216 Gr. WCB or equivalent	A351 Gr. CF8M or equivalent
36	Seal Retainer Ring	A216 Gr. WCB or equivalent	A351 Gr. CF8M or equivalent
37	Cover Flange	A216 Gr. WCB or equivalent	A351 Gr. CF8M or equivalent
38A	Gland Flange	A216 Gr. WCB or equivalent	A351 Gr. CF8M or equivalent
38L	Gland Follower	A216 Gr. WCB or equivalent	A351 Gr. CF8M or equivalent
40	Shaft	A564 T630 DH1150-17.4PH	A564 T630 DH1150-17.4PH
41	Bearing	Graphite or A479 316SST/Chrome plated	Graphite or A479 316SST/Chrome plated
42	Seal Ring	A240 316 or S31803 SST/Graphite	A240 316 or S31803 SST/Graphite
43A	Disc Gasket	316 SST with Graphite-Spiral Wound	316 SST with Graphite-Spiral Wound
43B	Cover Gasket	316 SST with Graphite-Spiral Wound	316 SST with Graphite-Spiral Wound
44	Thrust Bearing	A479 316SST or equivalent/Chrome plated	A479 316SST or equivalent/Chrome plated
45	Thrust Bearing Washer	A479 316SST or equivalent	A479 316SST or equivalent
46	Thrust Bearing Retainer Clip	A240 316SST or equivalent	A240 316SST or equivalent
47	Disc Key	A479 316SST or equivalent	A479 316SST or equivalent
48	Actuator Key	A311 C1045 or equivalent	A311 C1045 or equivalent
49	Serial Plate	304 SST	304 SST
50A	Packing End Ring	Braided reinforced graphite	Braided reinforced graphite
50B	Packing Mid Ring	Die formed graphite	Die formed graphite
51	Retaining clip	A240 316SST or equivalent	A240 316SST or equivalent
52	Gland Stud	A193 B8M CI 2	A193 B8M CI 2
53	Gland Nut	A194 8M	A194 8M
54	Seal Retainer Screw	A193 B8M CI 1	A193 B8M CI 1
55	Cover screw	A193 B8M CI 1	A193 B8M CI 1
56	Centring Screw	316 SST or equivalent	316 SST or equivalent
58	Bearing Protector	Braided graphite	Braided graphite

VALVE MATERIAL PRESSURE

TEMPERATURE RATINGS

MAXIMUM TEMPERATURE OF (°F)	CL150 WORKING PRESSURE, PSIG		CL300 WORKING PRESSURE, PSIG		CL600 WORKING PRESSURE, PSIG	
	CARBON STEEL A216 GR. WCB	316SS A351 GR. CF8M	CARBON STEEL A216 GR. WCB	316SS A351 GR. CF8M	CARBON STEEL A216 GR. WCB	316SS A351 GR. CF8M
-20 to 100	285	275	740	720	1480	1440
200	260	235	680	620	1360	1240
300	230	215	655	560	1310	1120
400	200	195	635	515	1265	1025
500	170	170	605	480	1205	955
600	140	140	570	450	1135	900
650	125	125	550	440	1100	885
700	110	110	530	435	1060	870
750	95	95	505	425	1015	855
800	80	80	410	420	825	845
850	Note A	65	Note A	420	Note A	835
900	-	50	-	415	-	830
950	-	35	-	385	-	775
1000	-	20	-	365	-	725
1050	-	-	-	360	-	720
1100	-	-	-	305	-	610
1150	-	-	-	235	-	475
1200	-	-	-	185	-	370
1250	-	-	-	145	-	295
1300	-	-	-	115	-	235
1350	-	-	-	95	-	190
1400	-	-	-	75	-	150
1450	-	-	-	60	-	115
1500	-	-	-	40	-	85

Note A: Permissible, but not recommended for prolonged usage above 800°F.

VALVE MATERIAL PRESSURE TEMPERATURE RATINGS

COMPONENT	MATERIAL	TEMPERATURE RANGE (°F)	MAXIMUM BODY PRESSURE RATING AT 100°F			NOTE	
			CL150	CL300	CL600		
BODY AND DISC	STANDARD	WCB - ASTM A216 (carbon steel)	-20 to 1000	285	740	1480	(1)
		CF8M - ASTM A351 (316SST)	-425 to 1500	275	720	1440	(3)(4)
	OPTIONAL	LCB - ASTM A352 (carbon steel low temp.)	-50 to 650	265	695	1395	
		LCC - ASTM A352 (carbon steel low temp.)	-50 to 650	290	750	1500	
		LC3 - ASTM A352 (carbon steel low temp.)	-150 to 650	290	750	1500	
		WC6 - ASTM A217 (Cr-Mo steel)	-20 to 1100	290	750	1500	(2)(3)
		WC9 - ASTM A217 (Cr-Mo steel)	-20 to 1100	290	750	1500	(2)(3)
		CF8 - ASTM A351 (304SST)	-425 to 1500	275	720	1440	(3)(4)
		CF8C - ASTM A351 (347SST)	-325 to 1500	275	720	1440	(3)(4)
		CG8M - ASTM A351 (317 SST)	-425 to 1000	275	720	1440	(3)
		CN7M - ASTM A351 (ALLOY 20)	-325 to 600	230	600	1200	(5)
		CD4MCuN - ASTM A351 (Duplex)	-425 to 600	290	750	1500	
		CZ100 - ASTM A494 (Nickel)	-325 to 600	140	360	720	(6)
		CY40 - ASTM A494/ASTM N06600 (Inconel® 600)	-325 to 800/1200	290	750	1500	(6)(3)
		M30C/M35-1 - ASTM A494 (Monel® 400)	-325 to 700/900	230	600	1200	(6)
		CW12MW - ASTM A494 (Hastelloy® C)	-325 to 1000	230	600	1200	(5)
		C95500 - ASTM B148 (Ni-Al-Bz)	-425 to 600	Contact Score Valves sales rep.			
Grade 3 Titanium	-75 to 600	Contact Score Valves sales rep.					
SEAT	STANDARD	316L SST overlay on carbon steel	Per body material				
		Integral cast on stainless and exotic	Per body material				
	OPTIONAL	Stellite® 6	-425 to 1500				
		Stellite® 21	-425 to 1000+				
SHAFT	STANDARD	Incoloy® 825	-20 to 1200				
	OPTIONAL	S17400 (17.4 PH DH1150) - Full Rated	-325 to 850			(7)	
		316SST - Reduced Rated	-425 to 600			(8)(11)	
		Alloy 20 - Reduced Rated	-325 to 800			(8)(11)	
		Inconel® 600 - Reduced Rated	-325 to 900			(8)(11)	
		Inconel® 625 - Reduced Rated	-325 to 1200			(8)(11)	
		Monel® K500 - Full Rated	-325 to 900			(11)	
		Inconel® 718/750 - Full Rated	-20 to 1500			(11)	
		Stainless or exotic equal to body grade	Per body material			(8)(11)	
		SEAL STACK	STANDARD	316SST Laminated w/ Graphite	-400 to 1200		
Duplex 2205 Laminated w/ Graphite	-400 to 1200					(7)(9)	
OPTIONAL	316SST Soild		-400 to 1200				
	316SST Soild w/ Stellite® 21 overlay		-400 to 1500				
	Inconel® 600 Laminated w/ Graphite		-20 to 1200			(9)	
	Inconel® 625 Laminated w/ Graphite		-20 to 1300			(9)	
	Monel® 400 Laminated w/ Graphite		-400 to 900				
	Hastelloy® C276 Laminated w/ Graphite		-325 to 1000			(9)	
BEARING	STANDARD	CL150 - Graphite	-400 to 1700			(10)	
		CL300 and CL600 - 316SST chrome plated	-325 to 1500				
	OPTIONAL	Nitronic® 60 (CL150)	-325 to 1500				
		Graphite (CL300 and CL600)	-400 to 1700			(10)(8)	
		PTFE composition	-425 to 325			(8)	
		Stellite® 6	-425 to 1500				
		Bronze	-425 to 600			(8)	
Ceramic composition	-20 to 2500			(8)			
PACKING	STANDARD	Graphite	-400 to 1200			(9)	
		PTFE Chevron	-425 to 450				
	OPTIONAL	PTFE Braided	-425 to 450				

- Per ASME B16.34: Permissible but not recommended for prolonged use above 800°F.
- Per ASME B16.34: Use normalized and tempered material only.
- Per ASME B16.34: Use of a flanged valve in CL150 ANSI above 1000°F not recommended.
- Per ASME B16.34: At temperatures over 1000°F, use only when the carbon content is 0.04% or higher.
- Per ASME B16.34: Use solution annealed material only.
- Per ASME B16.34: Use annealed material only.
- Long exposure above 600°F may cause embrittlement.
- Use of this material may result in a reduced pressure rating. Contact Score Valves sales representative.
- Upper temperature limit reduced to 975°F in oxidizing media.
- Upper temperature limit reduced to 650°F in oxidizing atmosphere.
- Upper temperature limit is specified as a general guide based on code, specification and minimum torsional seating requirements. Use of material above this limit may violate these requirements. Contact a Score sales or engineering representative for specific application material evaluation.

VALVE DATA

TORQUE REQUIREMENTS, WEIGHT, MAXIMUM FLOW COEFFICIENT, AND FLOW CURVE

TORQUE REQUIREMENTS

CLASS 150								
NOMINAL SIZE	PREFERRED DIRECTION (IN.-LB.)				NON-PREFERRED DIRECTION (IN.-LB.)			
	HALF RATED AT 145 PSI		FULL RATED AT 285 PSI		HALF RATED AT 145 PSI		FULL RATED AT 285 PSI	
	SEATING	UNSEATING	SEATING	UNSEATING	SEATING	UNSEATING	SEATING (MAX)	UNSEATING
3	600	600	800	1200	1100	300	1600	600
4	900	900	1200	1700	1600	500	2300	800
6	2200	2200	3000	4200	3900	1100	5600	2000
8	3000	3000	4000	5600	5300	1500	7500	2600
10	3900	3900	5100	7300	6800	1900	9700	3400
12	8600	8600	11400	16100	15100	4300	21500	7500
14	9600	9600	12700	18000	16800	4800	24000	8400
16	11600	11600	15400	21800	20300	5800	29000	10200
18	17200	17200	22800	32300	30100	8600	43000	15100
20	20000	20000	26500	37500	35000	10000	50000	17500
24	23600	23600	31300	44300	41300	11800	59000	20700
28	40000	40000	53000	75000	70000	20000	100000	35000
30	46800	46800	62000	87800	81900	23400	117000	41000
36	72000	72000	95400	135000	126000	36000	180000	63000
40	94000	94000	124600	176300	164500	47000	235000	82300
42	112000	112000	148400	210000	196000	56000	280000	98000
46	128000	128000	169600	240000	224000	64000	320000	112000
48	159200	159200	210900	298500	278600	79600	398000	139300
54	248000	248000	328600	465000	434000	124000	620000	217000
60	292000	292000	386900	547500	511000	146000	730000	255500

CLASS 300								
NOMINAL SIZE	PREFERRED DIRECTION (IN.-LB.)				NON-PREFERRED DIRECTION (IN.-LB.)			
	HALF RATED AT 370 PSI		FULL RATED AT 740 PSI		HALF RATED AT 370 PSI		FULL RATED AT 740 PSI	
	SEATING	UNSEATING	SEATING	UNSEATING	SEATING	UNSEATING	SEATING	UNSEATING
3	1000	1000	1400	2000	1800	500	2600	900
4	1600	1600	2100	2900	2700	800	3900	1400
6	2600	2600	3400	4800	4500	1300	6400	2200
8	6200	6200	8200	11600	10900	3100	15500	5400
10	7400	7400	9800	13800	12900	3700	18400	6400
12	9200	9200	12200	17300	16100	4600	23000	8100
14	15000	15000	19800	28100	26200	7500	37400	13100
16	23200	23200	30700	43500	40600	11600	58000	20300
18	27200	27200	36000	51000	47600	13600	68000	23800
20	35200	35200	46600	66000	61600	17600	88000	30800
24	60000	60000	79500	112500	105000	30000	150000	52500
26	82000	82000	108700	153800	143500	41000	205000	71800
28	92400	92400	122400	173300	161700	46200	231000	80900
30	120000	120000	159000	225000	210000	60000	300000	105000
36	172000	172000	227900	322500	301000	86000	430000	150500
42	310400	310400	411300	582000	543200	155200	776000	271600

CLASS 600								
NOMINAL SIZE	PREFERRED DIRECTION (IN.-LB.)				NON-PREFERRED DIRECTION (IN.-LB.)			
	HALF RATED AT 740 PSI		FULL RATED AT 1480 PSI		HALF RATED AT 740 PSI		FULL RATED AT 1480 PSI	
	SEATING	UNSEATING	SEATING	UNSEATING	SEATING	UNSEATING	SEATING	UNSEATING
6	9600	9600	12700	18000	16800	4800	24000	8400
8	13200	13200	17500	24800	23100	6600	33000	11600
10	21600	21600	28600	40500	37800	10800	54000	18900
12	47600	47600	63100	89300	83300	23800	119000	41700
14	55200	55200	73100	103500	96600	27600	138000	48300
16	68400	68400	90600	128300	119700	34200	171000	59900
18	81600	81600	108100	153000	142800	40800	204000	71400
20	101200	101200	134100	189800	177100	50600	253000	88600
24	134000	134000	177600	251300	234500	67000	335000	117300
30	314800	314800	417100	590300	550900	157400	787000	275500

RECOMMENDED TORQUE MULTIPLICATION FACTORS FOR ACTUATOR SELECTION	
ANSI/FCI Class V or VI Shutoff	0.9 x Seating
Solid Seal Class V Shutoff	1.0 x Seating
Infrequent Operation	1.2
Media Buildup Prone/Dirty Service/Cryo Service	1.2
Safety Critical and Emergency Shutdown Valve	1.2 to 1.5

- › Torque requirements are approximate and subject to change without notice.
- › Table values are for standard construction, service, and temperature range resulting in zero leakage API 598 shutoff.
- › Torques may be interpolated on a linear scale between half and full rated pressures.
- › Run torques equal 30% of full rated preferred direction unseating torque for both preferred and non-preferred direction.

Torque multiplication factors are not cumulative.

VALVE DATA

VALVE WEIGHT (LB)

ASME CLASS/ BAR	STYLE	3"	4"	6"	8"	10"	12"	14"	16"	18"	20"	24"	26"	28"	30"	36"	40"	42"	46"	48"	54"	60"
150/16 (LB)	Wafer	24	35	44	74	94	157	205	295	398	490	762	-	1120	1374	2165	2963	3244	3850	4374	6018	7565
	Lug	27	42	55	90	118	202	287	373	530	686	1015	-	1558	1831	2973	4166	4596	5620	6389	8460	10700
	DF Short	40	64	84	136	178	290	378	482	672	792	1122	-	1852	2061	3347	4516	4976	6160	7001	9080	11600
	DF Long	51	76	104	150	249	473	543	597	820	950	1342	-	2100	2398	3710	5200	5634	7300	8300	10700	13500
300/40 (LB)	Wafer	33	43	70	121	169	244	370	443	555	710	1068	1560	2050	2500	3150	-	3800	-	-	-	-
	Lug	35	54	77	153	224	286	470	621	880	1064	1683	2150	2620	3150	4300	-	5200	-	-	-	-
	DF Short	51	66	145	238	314	436	580	778	975	1200	1710	2280	2850	3378	4747	-	5900	-	-	-	-
	DF Long	63	82	210	345	454	594	871	1277	1450	1900	2600	3160	3710	4300	5400	-	6500	-	-	-	-
600/100 (LB)	Wafer	-	-	106	160	264	403	558	675	1050	1200	1700	-	-	-	-	-	-	-	-	-	-
	Lug	-	-	140	218	373	564	784	1027	1283	1545	2347	-	-	-	-	-	-	-	-	-	-
	DF Short	-	-	293	357	448	774	940	1230	1534	1845	2797	-	-	-	-	-	-	-	-	-	-
	DF Long	-	-	310	550	910	1150	1400	2100	2534	3075	4588	-	-	-	-	-	-	-	-	-	-

*Valve weights are approximate and subject to change without notice. Weights for >24" valves are based on ASME B16.47 series A flange design.

MAXIMUM FLOW COEFFICIENT (CV)

ASME CLASS/ BAR	3"	4"	6"	8"	10"	12"	14"	16"	18"	20"	24"	26"	28"	30"	36"	40"	42"	46"	48"	54"	60"
150/16	100	225	890	1870	3100	3900	4660	6430	8400	11630	18230	-	24150	28600	38900	50800	52600	67000	70500	95900	114600
300/40	100	225	680	1330	2435	3688	4542	5908	7751	10716	16140	19800	21950	24600	36800	-	47100	-	-	-	-
600/100	-	-	530	1230	2085	2198	2750	5120	6880	9864	12960	-	-	20900	-	-	-	-	-	-	-

FLOW CURVE

For control applications a wide variety of actuators and accessories can be provided. At moderate pressure drop conditions, turndown approaching 100 to 1 can be achieved because of the camming action of the disc opening. The disc lifts off the seat very quickly and an equal percentage control curve is produced between 15° to 75°.

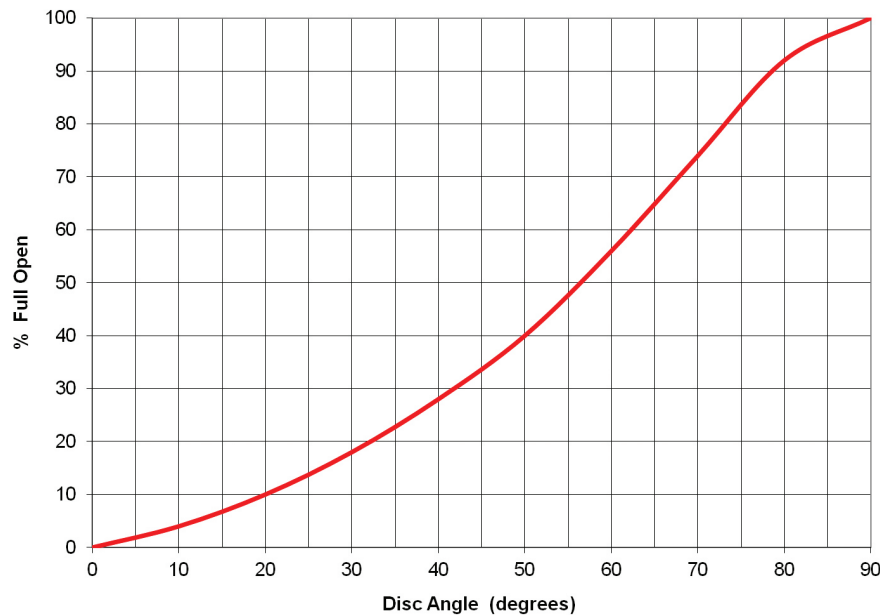

TRICENTRIC® BD SERIES VALVE MODEL NUMBERING SYSTEM

PRESSURE RATING		VALVE SIZE		VALVE STYLE	FLANGE STANDARD	BODY MATERIAL	SEAT MATERIAL	DISC MATERIAL	SEAL STACK MATERIAL	BEARING MATERIAL	SHAFT MATERIAL	PACKAGING MATERIAL	ADDITIONAL FEATURES	OPERATOR
BODY	TRIM	BODY	TRIM											

Standard Valves: Standard materials of construction are noted in bold italics. Standard Construction Temperature Range: WCB: -20°F to 750°F, CF8M: -50°F to 750°F. Closure tested to ANSI/FCI 70.2 Class VI in preferred direction.

PRESSURE RATING (2 DIGITS)

Body (1 Digit)

1 = 150 ASME
3 = 300 ASME
6 = 600 ASME
9 = 900 ASME

Trim (1 Digit)

1 = 150 ASME
3 = 300 ASME
6 = 600 ASME
9 = 900 ASME

VALVE SIZE (4 DIGITS)

Indicates nominal valve size in inches. Standard sizes:

Body (2 Digits)

03, 04, 06, 08, 10, 12, 14,
16, 18, 20, 24, 30, 36, 42,
48, 54, 60, 64, 72, 84

Body (2 Digits)

03, 04, 06, 08, 10, 12, 14,
16, 18, 20, 24, 30, 36, 42,
48, 54, 60, 64, 72, 84

VALVE STYLE (1 DIGIT)

A = Plain wafer
B = Lugged wafer
C = Double flanged ISO 5752 face to face
D = Double flanged ASME B16.10 face to face
E = Butt weld (cast only)
X = Other

FLANGE STANDARD (1 DIGIT)

A = ASME B16.5 (3" to 24")
B = ASME B16.47 Series A (26" to 60")
C = ASME B16.47 Series B (26" to 60")
X = Other

BODY (1 DIGIT)

A = **A216 Gr. WCB**
B = **A351 Gr. CF8M**
C = A352 Gr. LCB
D = A352 Gr. LCC
E = A217 Gr. C5 Chrome-Moly
F = A217 Gr. WC6
G = Duplex CD3MN
H = A351 Gr. CN7M Alloy 20
J = A494 Gr. CY40 Inconel® 600
K = A494 Gr. CW2M Hastelloy® C
L = A494 Gr. M-30-C Monel®
M = B148 Gr. C95500 Nickel-Aluminum-Bronze
N = Grade 2 Titanium
X = Other

SEAT MATERIAL (1 DIGIT)

A = **316L SST**
B = **Integral w/ body**
C = Stellite® 21
D = Stellite® 6
X = Other

DISC (1 DIGIT)

A = **A216 Gr. WCB**
B = **A351 Gr. CF8M**
C = A352 Gr. LCB
D = A352 Gr. LCC
E = A217 Gr. C5 Chrome-Moly
F = A217 Gr. WC6
G = Duplex CD3MN
H = A351 Gr. CN7M Alloy 20
J = A494 Gr. CY40 Inconel® 600
K = A494 Gr. CW2M Hastelloy® C
L = A494 Gr. M-30-C Monel®
M = B148 Gr. C95500 Nickel-Aluminum-Bronze
N = Grade 2 Titanium
X = Other

SEAL STACK (2 DIGITS)

Metal Lamination (1st Digit)

A = **Duplex 2205 (Full rated preferred ≥ 30" CL150, CL300, and all CL600; All full rated bidirectional)**
B = **316 SST (Full rated preferred ≤ 24" CL150 and CL300 and all half rated differential)**

C = Alloy 20
D = Inconel® 600
E = Hastelloy® C 276
F = Monel® 400
G = Titanium
H = Stellite® 21
J = Stellite® 6
X = Other

Gasket Lamination (2nd Digit)

A = **Graphite**
B = None (solid seal)
C = Klingersil C4401
D = RPTFE
X = Other

BEARING (1 DIGIT)

A = **316 stainless hard surfaced (CL150 bidirectional and all full rated CL300, 600, 900)**
B = **Carbon Graphite (CL150 preferred direction and all 1/2 rated bidirectional)**

C = Nitronic® 60
D = Duplex 2205 hard surfaced
E = Alloy 20 hard surfaced
F = Inconel® 600 hard surfaced
G = Hastelloy® C-276 hard surfaced
H = Monel® 400 hard surfaced
J = Titanium hard surfaced
K = Stellite® 21
L = Stellite® 6
M = Bronze C93200
X = Other

SHAFT (1 DIGIT)

A = **17.4 PH DH 1150**
B = 316 SST
C = Duplex 2205
D = Alloy 20
E = Inconel® 600
F = Inconel® 625
G = Inconel® 718
H = Hastelloy® C-276
J = Monel® K500
K = Titanium Grade 5
X = Other

PACKING (1 DIGIT)

A = **Graphite (Die-formed ribbon with braided reinforced end rings-corrosion inhibited)**
B = PTFE Chevron Type (<1000 psig)
C = PTFE 316SST Chevron Type(>1000 psig)
D = PTFE braided
E = Graphite low emission (100 ppm)
X = Other

ADDITIONAL FEATURES

(As many digits as required, list as required in alphabetical order. Section is omitted if no additional features apply to the particular design).

A = Low temperature service (-325°F to -50°F)
Modified bearings and lubricant.
B = High temperature service (750°F to 1000°F)
Modified bearings and lubricant.
C = High Temperature service (1000°F to 1200°F)
Modified Bearings and lubricant. CF8M components require .04% min. Carbon content per ASME B16.34
D = Cryogenic Extension (-325°F to -50°F)
› Standard length: 12" for 3" to 10" CL150 and 3" to 6" CL300
› Standard length: 18" for 12" CL150, 8" CL300, 6" CL600 and larger valves
› Optional lengths available in 2" increments
E = Heat Extension (975°F and up)
› Standard length: 12" for 3" to 10" CL150 and 3" to 6" CL300
› Standard length: 18" for 12" CL150, 8" CL300, 6" CL600 and larger valves
› Optional lengths available in 2" increments
F = Steam jacket
G = Live loaded packing – Carbon steel (For stainless and other materials use "GX")
H = Steam traced shaft
I = Steam traced disc
J = Bearing lube purge
K = Packing lube
L = Packing bleed
M = Block and bleed seal
N = Weir specification P-71-25
O = NDE-HT Hardness test body and disc casting to NACE MR0103 or customer spec (must specify)
P = NDE-MT/PT Mag particle/penetrant test Body and Disc casting to ASME B16.34
R = NDE-RT radiographic testing of Body casting per ASME B16.34
S = Extended bracket (Double standard bracket height)
T = Degreasing
U = Bidirectional API 598 high and low resilient seat closure leakage
V = Bidirectional API 598 high and low metal seat closure leakage
W = Bidirectional API 598 high and low Preferred: resilient Non-preferred: metal seat closure leakage
X = Other special feature: (must fully specify)
Y = Preferred Dir. API 598 high and low resilient seat closure leakage
Z = NACE MR0103 or 0175 compliant (specify which spec)

OPERATOR (1 DIGIT)

A = Actuator
B = Bare stem
C = Mounting of customer supplied actuator
G = Manual gear with handwheel

*Score Valves may substitute equivalent wrought material.

*Design is subject to change without notice. Consult Score Valves for confirmation of products and/or materials availability.

Model Numbering Example: Valve model 111212AAAA-BBABA-B contains- ASME CL 150 valve body and trim, size 12" body and trim, plain wafer style, with ASME B16.5 flanges, A216 Gr. WCB body w/ 316L SST seat, A351 CF8M disc, 316 SST w/ graphite laminated seal ring, carbon graphite bearings, 17.4 ph DH1150 shaft, graphite packing and bare stem (No gear operator or actuator included with valve).



SCOREVALVES.COM | SALES@SCOREVALVES.COM

P 780.466.6782 | **F** 780.465.6979 | 9821 - 41 AVENUE NW EDMONTON, AB | T6E 0A2

Score Valves reserves the right to change this content without notice. Monel®, Inconel® and Incoloy® are registered trademarks of Special Metals Corporation. Stellite® is a registered trademark of Kennametal Inc. Hastelloy® is a registered trademark of Haynes International Inc. HIGHSEAL® is a registered trademark of Score Valves. Nitronic® is a registered trademark of AK Steel. TRICENTRIC® is a registered trademark of Weir Valves & Control USA, Inc.